

MR-40 Mounting Template

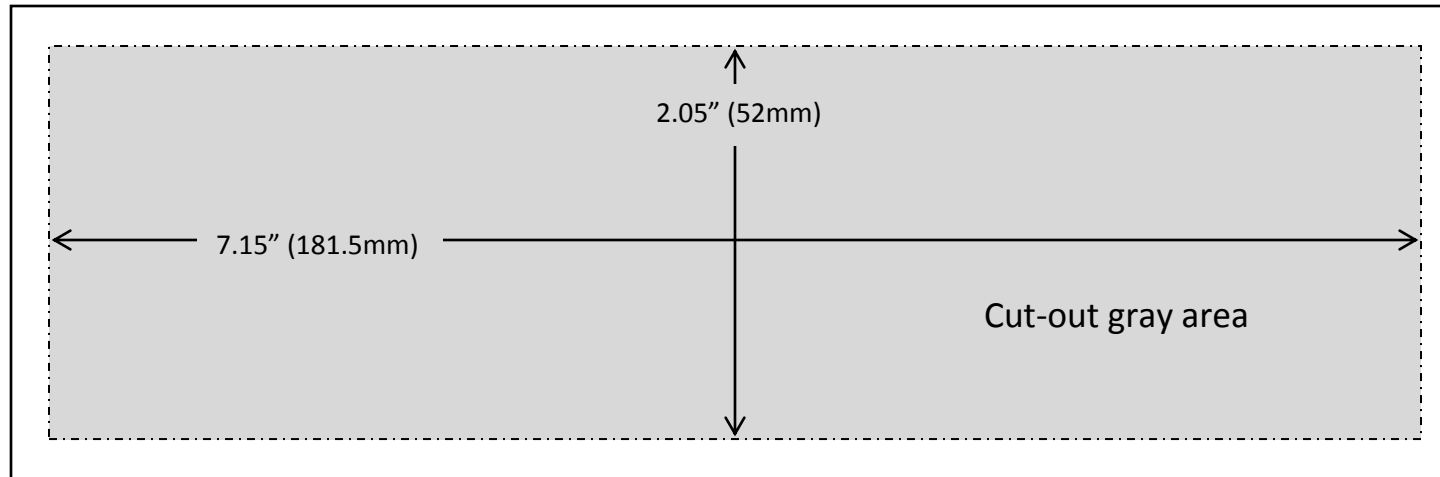

SCALE = 1:1
Faxing or reproducing
may change scale

Installation: Find a suitable location making sure there is clearance for the installed depth. Use a hole saw or other suitable device to make a cutout.

