

## MRD85i OWNER'S MANUAL



- **BUILT-IN BLUETOOTH WIRELESS AUDIO**
  - **SIRIUS READY (SCC1 Tuner required)**
- **DMD READY (Digital Music Device like iPod®, MP3, Smartphone devices)**
  - **USB READY**
  - **FLIP DOWN FRONT PANEL**
  - **SD MEMORY CARD READY**
  - **AM/FM MARINE STEREO**
    - **RDS READY**

## TABLE OF CONTENTS

Installation.....	3
Wiring Diagram.....	5
Button Description.....	7
Basic Operation.....	8
Radio Operation.....	10
Sirius Operation.....	12
iPod® Operation.....	15
Bluetooth Operation.....	16
Auxiliary Operation.....	16
USB Operation.....	17
SD Card Operation.....	18
Compatible Accessories.....	20
Trouble shooting.....	21
Technical Specifications.....	22
Warranty Information.....	23
Warranty Registration.....	25

## INSTALLATION

- **IMPORTANT!** Before mounting be sure there is sufficient room to accommodate the unit and that there is sufficient ventilation.
- Before installing the unit, connect the wiring temporarily making sure the system works properly.
- Only use the parts included with the unit to ensure proper installation.
- Receiver should be mounted within  $30^{\circ}$  (+ or  $- 15^{\circ}$ ) from Horizontal. If installation angle exceeds  $30^{\circ}$  from horizontal, the unit might not give its optimum performance.

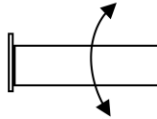

- Avoid installing the unit where it would be subject to high temperatures such as direct sunlight or hot air from heaters or the engine or where it would be subject to dust, dirt or excessive vibration.
- Use the template provided to make the cutout.
- With the front panel down insert the 4 provided screws. Use the 5mm nut and bracket provided to stabilize the rear of the radio.
- Be sure to mount the unit to a strong, solid surface which will not give way under the stress of waves pounding the hull.

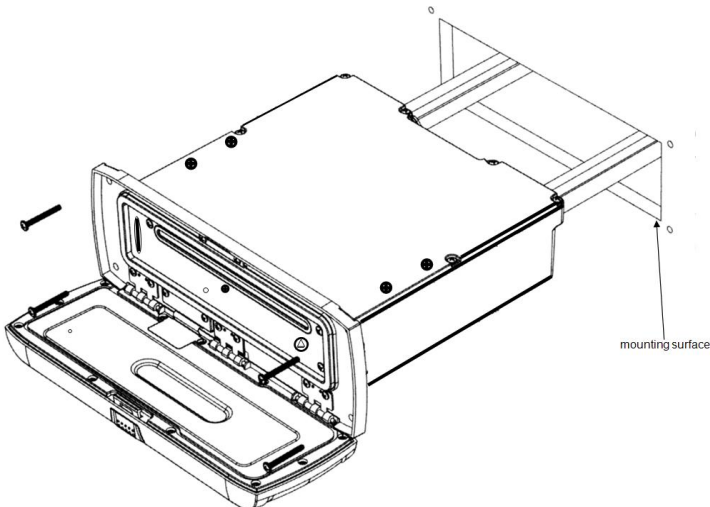

## Optional Mounting Techniques

Optional gimbal mount  
bracket installation  
Model # GM-MRD80



Optional Overhead / Under  
Dash mount installation  
Model # RM-10



# WIRING DIAGRAM

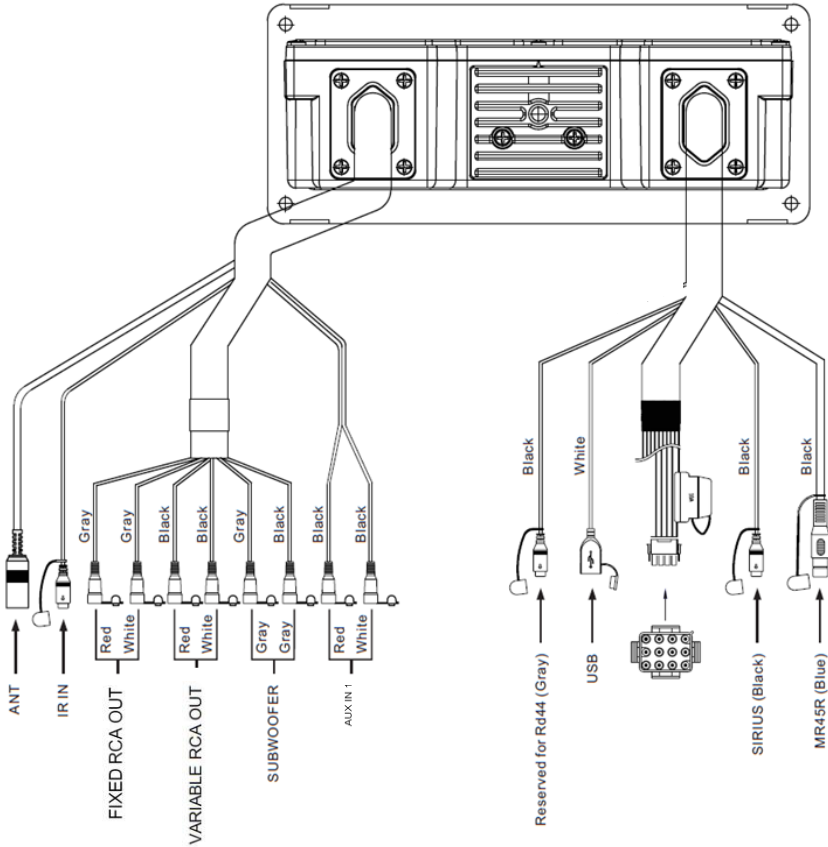

## Wiring Details:

Use the wired plug end (Pigtail) provided to make power and speaker connections according to the diagram below. Using this connector will make it easy to disconnect the radio for adding additional features or service. Removing the factory plug end will void warranty.

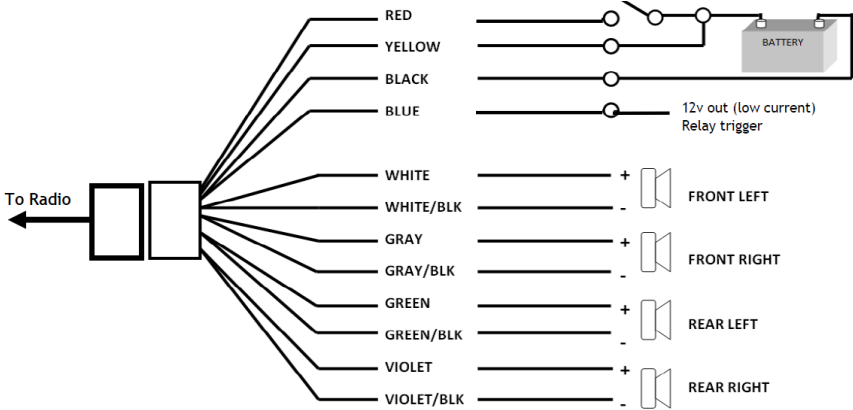

Wire Color	Function
Yellow	1 B+ (+12VDC)
Green w/stripe	2 Rear Left Speaker-
Green	3 Rear Left Speaker+
Red	4 ACC (+12VDC)
White w/stripe	5 Front Left Speaker-
White	6 Front Left Speaker+
Blue	7 Relay Trigger
Gray w/stripe	8 Front Right Speaker-
Gray	9 Front Right Speaker+
Black	10 Ground (Neg)
Violet w/stripe	11 Rear Right Speaker-
Violet	12 Rear Right Speaker+

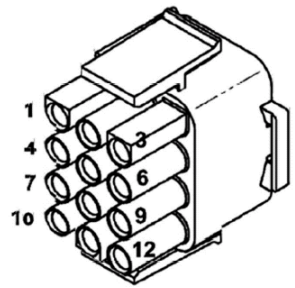

**Power Wire Specifications:**

**Yellow Wire** - Connect this wire to a constant +12V source.

**Red Wire** - Connect this wire to a switched +12V source such as an ignition or accessory switch.

**Black Wire** - Connect this wire to the negative battery terminal or other good power ground.

**Blue Wire** - This wire outputs a 12V signal when the MRD80 turns on. It is used to remotely turn on external amplifiers.

**Notes:**

- Use the included plug/wire bundle to connect to the power source and speakers.

- The Yellow, Red and Black power wires should be 14AWG or larger depending on the length to the battery. NEVER operate the unit without the proper power and ground wire.
- NEVER ground the speaker leads and NEVER allow the speaker leads to come in contact with each other. The speaker wire should be at least 16 gauge or larger. Be sure to observe the correct polarity on the speaker connections
- Use quality crimp connectors to connect wires together. Seal the connection well with electrical tape.
- NEVER operate the unit without proper fusing. Fuse holder must be located within 2 feet from the battery. This fuse is to protect the vessel, not the electronics. In case of a short, the fuse will blow instead of the wire burning up. Using other than the recommended fuse ratings at the battery and at the unit may cause damage to the unit and will void your warranty.
- Whenever possible, use cable ties, mounting clamps and similar wiring aids. Adding stress relief loop to wiring is also advisable to prevent straining or breakage.
- If after reading the directions you feel uncomfortable about installing the unit, or not equipped or competent to do so, you should have this installed by a professional installer

## BUTTON DESCRIPTION

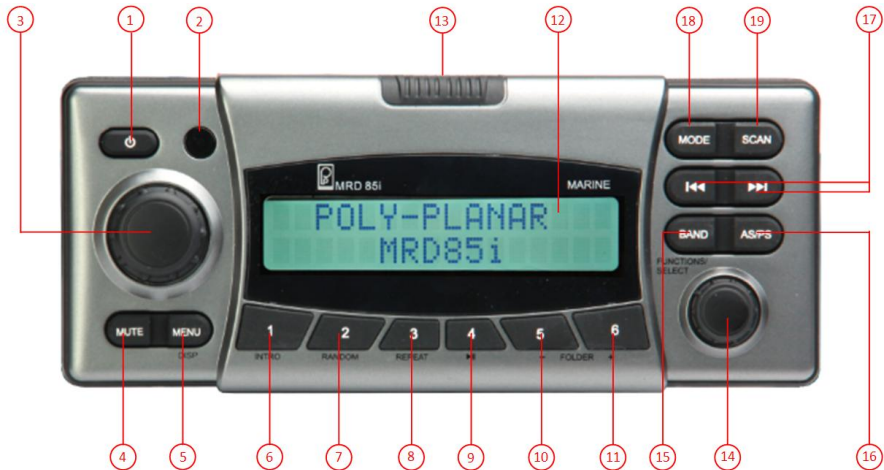

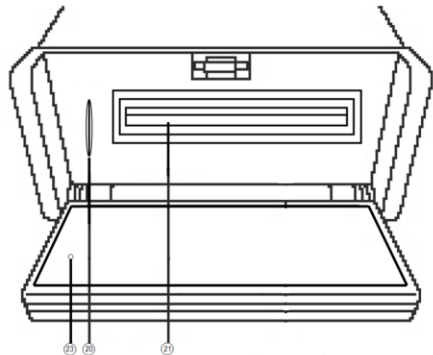

1.  - Power Button
2. IR Receiver
3. Volume UP/DOWN Knob
4. MUTE – Mute Button
5. MENU/DISP – Menu/Display Button
6. 1/INTRO - Preset 1/Scan Button
7. 2/RANDOM - Preset 2/Random Button
8. 3/REPEAT - Preset 3/Repeat Button
9. 4/▶|| - Preset 4/(Play/Pause) Button
10. 5/▬ - Preset 5/Folder down (optional)
11. 6/⊕ - Preset 6/Directory up (optional)
12. LCD Display
13. Front Panel Latch Button
14. Function/Select Knob
15. BAND - Band Button
16. AS/PS - Auto Store and Preset Scan Button
17. ▶|◀ - Control Button
18. MODE - Mode Button
19. SCAN – Scan Button
20. SD Card Slot
21. DMD Drawer
23. RESET



## BASIC OPERATION

### SWITCHING ON/OFF THE UNIT

Press  **button** to turn on the unit. Press and hold  **button** for 4 sec to turn off the unit

### OPENING THE FRONT PANEL

Place thumb on the **front panel latch button**. Firmly depress the button while pulling the front panel open. Keep door firmly closed except when changing discs.

### ADJUSTING THE AUDIO LEVELS

Press **Volume knob** to enter audio level menu (Bass/Treble/Balance/Fader/Sub/EQ/ID3*(for MP3 music file only)*) then use the **Volume Knob** to adjust to your desired setting. Press **Volume knob** again to select different functions. Unit will return to normal previous display if left untouched for 5 seconds.



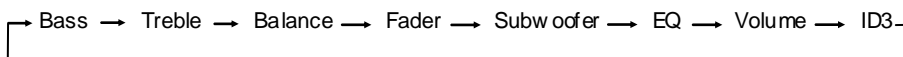

## EQ AND SUBWOOFER SETTING

Press **Volume knob** repeatedly until EQ menu appears then rotate the **volume knob** to change EQ setting selection.

**EQ: 1** – Optimized for Poly-Planar SP200R or SFS101 spa speakers or small diameter (3”) flush mount speakers. MS55 subwoofer is recommended (back channels). Adjust subwoofer setting by pressing **Volume Knob** repeatedly until Subwoofer menu appears on the display then use **Volume Knob** to adjust to your desired setting.

**EQ: 2** - Optimized for Poly-Planar MA7020 spa speaker. MS55 subwoofer is recommended (back channels). Adjust subwoofer setting by pressing **Volume Knob** repeatedly until Subwoofer menu appears on the display then use **Volume Knob** to adjust to your desired setting.

**EQ: 3** - Optimized for Poly-Planar MA7500 box speaker. MS55 subwoofer is recommended (back channels). Adjust subwoofer setting by pressing **Volume Knob** repeatedly until Subwoofer menu appears on the display then use **Volume Knob** to adjust to your desired setting.

**EQ: 4** – Optimized for Poly-Planar MA7500 and/or MA9020 box speaker or any medium sized box style speakers. Using a subwoofer is optional.

**EQ: 5** - Optimized for Poly-Planar Platinum Series MA6500, MA6600 MA6800, MA6900 or other similar speakers. Using a subwoofer is optional.

**EQ: 6** - Optimized for Poly-Planar MA3013 and/or MA3030 small box speaker or any small sized flush mount or box style speakers. Using a subwoofer is optional.

**EQ: OFF** – Full range output (front and back channels) – Optimized for any type of speakers on both front and back channels

### ***Please Note:***

- Make sure the EQ setting are set for the speakers you are using.
- When using other brands, use the settings based on similar sized applications.

## TUNER FREQUENCY

Press and hold **Volume knob** for 5 seconds to enter current zone. Then

use the Volume Knob to adjust to different setting. Press **Function/Select knob** to confirm.

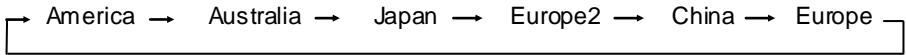

### MODE SELECTION

Press **MODE button** to choose desired listening mode. (e.g. Radio mode to USB mode to AUX IN mode... etc.)

### MUTE

Press **MUTE button** to mute the sound. Press again to return to previous volume level.

### DIMMER CONTROL

Press and hold **MENU button** for 3 seconds to display current setting. Then use the Volume Knob to adjust to different setting.

### RESET FUNCTION

Open front panel to display reset button. Use a ballpoint pen to press the reset button. The reset function is used in the following situations:

- All the function buttons do not operate.
- Error sign on the display.

## RADIO OPERATION

### SWITCHING TO RADIO MODE

Press **MODE button** to select radio mode.

### SELECTING THE FREQUENCY BAND

In radio mode, press **BAND button** to locate the desired band. The reception band will change in the following order:

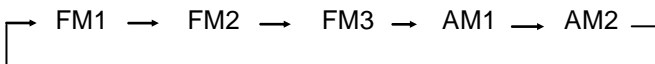

### SELECTING STATION

Press **▶▶/◀◀ button** to select a station. To use manual tuning, press and hold **▶▶/◀◀ button** or use **Function/Select knob**.

## **AUTOMATIC MEMORY STORING & PRESET SCAN (AS/PS)**

The **PRESET buttons** can be used to store 6 stations in each band (FM 1, FM 2, FM 3 and AM1, AM2) for convenient access to your favorite stations.

### ■ Automatic Storing

Press **AS/PS button**, the radio searches and checks the signal strength until one cycle search is finished then the strongest stations are stored into the corresponding preset number button automatically.

### ■ Manual Storing

1. Select the desired band.
2. Select the station you want to store in memory, then press and hold one of the **preset buttons** for 3 seconds until the corresponding preset button number appears.
3. Repeat steps 1 and 2 to program additional stations.

## **SCAN FUNCTION**

Press **SCAN button** to scan a station. The unit will keep on scanning every 7 seconds until you press the **SCAN button** again to stop scan function.

## **RDS FUNCTION (if available in your area)**

RDS (Radio Data System) - automatically switches to the strongest signal for the station you are listening so you don't have to retune your radio manually as you drive around.

If one of the three setting (AF, TA, PTY) is turned on you can check RDS station information by pressing **MENU button** then rotate **Function/Select knob** to view channel name, frequency or PTY information. If AF/TA/PTY settings are not turned on, you cannot see this information.

Below are some of the acronyms you will see on the display and what they stand for:

AF (Alternative Frequency) - shows that RDS is tuning to the strongest signal for the station you have selected. It retunes to a different frequency when you move into another area.

**AF operations:** press MENU button until the AF settings is on display. Rotate **Function/Select knob** to turn on/off AF function. The "AF" characters will be displayed on LCD if AF is on. When there is RDS signal currently playing and the signal is below a certain level, the radio will switch to the alternative stations which can receive good signal.

TA or TP (Traffic Announcement or Traffic Program) - automatically detects travel announcements on the nearest local radio station. This facility will raise the volume of the radio or interrupt a CD or cassette to alert you to a travel announcement. You can turn the facility on or off, as required.

**TA operations:** press **MENU button** until the TA settings is on display. Rotate **Function/Select knob** to turn on/off TA function. The "TA" characters will be displayed on LCD if TA is on. Pressing **▶▶/◀◀ button** will search stations with TP information. When the station with TP info is found, the TP will be displayed on LCD and the radio will switch to Radio mode when there is traffic alarm and will display "TRAFFIC" on LCD.

PTY (Program Type) - shows the type of program, e.g. sport, news, classical music.

**PTY operations:** press **MENU button** until the PTY settings is on display. Rotate **Function/Select knob** to turn On(Group 1/Group 2) or Off PTY function. If PTY and TA is on, PTY information will be displayed on LCD and the radio will also search all the stations with the same PTY. Use **Preset buttons (1~6)** for switching between different PTY's then press **▶▶/◀◀ button** to search the stations with the same PTY info.

#### **Group 1**

Preset 1 - "NEWS"  
Preset 2 - "INFO"  
Preset 3 - "EDUCATE"  
Preset 4 - "CULTURE"  
Preset 5 - "VARIES"  
Preset 6 - "ROCK M"

#### **Group 1**

Preset 1 - "LIGHT M"  
Preset 2 - "WEATHER"  
Preset 3 - "SOCIAL"  
Preset 4 - "TRAVEL"  
Preset 5 - "COUNTRY"  
Preset 6 - "FOLK M"

If there is no corresponding PTY, it will display "PTY none" and exit PTY mode.

## **SIRIUS OPERATION**

**Please Note:** You need SIRIUS SCC1 TUNER (not included) and you must activate your SIRIUS SCC1 TUNER before you can begin to receive the SIRIUS satellite radio service. Until you subscribe and activate the SIRIUS service, you can only access channel 000 (the SIRIUS ID channel) and 184 (Preview Channel). Tune to Channel 000

**to display your radio's unique 12-digit SIRIUS ID number (SID). This number is also available on the back of SIRIUS SCC1 Tuner. Write down this number and call 1-888-539-SIRIUS (1-888-539-7474) with your credit card handy to activate SIRIUS service. Or, you may go to website <https://activate.siriusradio.com//> to activate the service. If you do not subscribe the full service, the unsubscribed channel will display "CALL 888-539-SIRIUS to subscribe.**

If a SIRIUS SCC1 TUNER is already connected:

Press **MODE** button to change to SIRIUS mode.

If there is no SIRIUS SCC1 TUNER connected this mode will be skipped.

Please connect your SIRIUS SCC1 Tuner to the SIRIUS port located at the back of the unit. Then press **MODE** button to change to SIRIUS mode.

### **SELECTING A CHANNEL**

Press **▶▶/◀◀** button to select a channel. Press and Hold **▶▶** or **◀◀** button to go faster.

### **SEARCHING CHANNEL NUMBER MANNUALLY**

Press **AS/PS** button "Select: - - -" will show on the display. Use the **PRESET 1, 2 and 3** buttons to select the desired channel number. When finished, press **Function/Select knob** to confirm and play.

*Explain as follows:*

- If you want to search channel number 151, you have to press **1** button one time to get 1, then press **2** button five times to get 5, then press **3** button one time to get 1.
- Press **Function/Select knob** to confirm and play.

### **SELECT A CHANNEL BY CATEGORY**

Press **MENU** button twice to enter category setting then rotate **FUNCTION/SELECT** knob to turn on the category. Use the **FUNCTION/SELECT** knob again to navigate to all the categories available then when done selecting a category press **FUNCTION/SELECT** knob once or twice to confirm. The unit will only play the selected category.

### **SELECTING THE FREQUENCY BAND**

In SIRIUS mode, press **BAND** button to locate the desired band. The reception band will change in the following order:

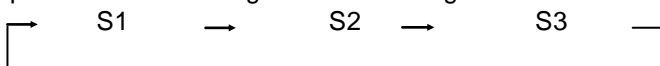

## **AUTOMATIC MEMORY STORING**

The **PRESET buttons** can be used to store 6 channels in each band (S1, S2 and S3) for convenient access to your favorite channels.

1. Select the desired band.
2. Select the channel you want to store in memory, then press and hold one of the preset buttons for 3 seconds until the corresponding preset button number appears.
3. Repeat steps 1 and 2 to program additional channels.

## **PARENTAL CONTROL**

You can lock any Sirius channels you do not want others to have access without your permission. The default code is "5220". In case you forget your code please disconnect the unit completely from the power.

### **- GUIDE ON HOW TO ENTER THE CODE USING THE PRESET BUTTONS**

Press preset 1 button five times to enter 5, press preset 2 button two times to enter 2 and press preset 3 button twice to enter 2. Since the last number is zero you do not need to press preset 4 button. When done, press **FUNCTION/SELECT knob** to confirm.

### **- TO LOCK A CHANNEL**

Select a channel that you wish to lock then press **SCAN button** "Lock Channel" will show on the display. Enter the code then press **FUNCTION/SELECT knob** to confirm "Channel Locked" will show on the display

### **- TO UNLOCK A CHANNEL**

Press **AS/PS button** to manually enter the channel you wish to unlock then press **FUNCTION/SELECT knob** then press **SCAN button** "Unlock Channel" will show on the display. Enter the code then press **FUNCTION/SELECT knob** to confirm "Channel Unlocked" will show on the display

### **- TO CHANGE THE CODE**

Press and hold **SCAN Button** "Old Code" will show on the display. Enter the old code then press **FUNCTION/SELECT knob** to confirm "New Code" will show on the display. Enter your new code then press **FUNCTION/SELECT knob** again to confirm "SetCode ok" will show on the display.

## DISPLAY INFORMATION

Press **MENU button** to access current display setting. If you want to change the display setting use the **FUNCTION/SELECT knob** to change the display setting to Artist, Song, Composer, Number, Name or Category information.

## iPod® OPERATION

### SWITCHING TO iPod® MODE

If a device is already connected:

Press **MODE button** to change to iPod® mode.

If there is no device connected the display will show “NO iPod®” please follow instructions below on how to connect your devices

Turn on your DMD device then open the front panel to connect the accessory cable to the connector on the right side of the device drawer then insert your music device in the drawer. Use one of the 2 adapters available to connect your device then push the drawer back in place. If operating an iPod® device please choose the flat 30 pin connector then press **MODE button** to change to iPod® mode. If you chose the 3.5mm plug adapter press **MODE button** to change to AUX Input 2 mode then refer AUX Operation on page 16 for further instructions. For iPod® mode, refer operation instructions below:

### SELECTING SONGS

Press **▶▶ or ◀◀ button** or rotate **Function/Select knob** to select a song. Press and Hold **▶▶ or ◀◀ button** to fast forward or rewind a song.

### SELECT A SONG BY CATEGORY

Press **MENU button** to enter current category then rotate **FUNCTION/SELECT knob** to select a new category: PLAYLIST/ARTIST/ALBUM/GENRE/SONG. Press **FUNCTION/SELECT knob** to enter the selected category. Press **FUNCTION/SELECT knob** again to navigate to all the songs or album then when done selecting a song or album press **FUNCTION/SELECT knob** once or twice to confirm and play. Press **MENU button** to return to the previous menu screen

### PAUSING/PLAYING

Press **4 button** to pause the playing. Press **4 button** again to resume playing.

## REPEAT PLAYING

Press **3 button** and select “Repeat: ONE” to repeat same song or press **3 button** again to select “Repeat: All” to repeat same album. Press **3 button** again and select “Repeat: OFF” to stop repeat function.

## PLAYING ALL SONGS/ALBUM IN RANDOM ORDER

Press **2 button** to play all songs/album in random order.

“Random: Track” – to play all tracks in random

“Random: Album” – to play all album in random

“Random: OFF” – to cancel the random function.

## BLUETOOTH OPERATION

### SWITCHING TO BLUETOOTH MODE

If a device is already paired:

Press **MODE button** to change to Bluetooth (BT) mode.

If there is no device paired the display will show “No BT Connect” please follow instructions below on how to pair your device

- 1) Make sure you are close enough to MRD85i
- 2) Open Bluetooth setting on your device
- 3) Choose “Poly-Planar” from the list of available Bluetooth link
- 4) Enter “0000” as the Bluetooth password (if required)
- 5) Once connected, you can now start playing your favorite music from your music device.
- 6) Operating Range is up to 30’ (will vary, dependent on installation)
- 7) To disconnect, please press “**AS/PS**” button for 3 seconds.
- 8) To clear the pairing, press “**BAND**” button for 3 seconds

### IMPORTANT NOTE:

*Some Bluetooth-enabled devices may take more than 45 seconds to initiate after pairing or does not pair at all. If this happen, try to turn off the stereo and the device and pair it again.*

### SELECTING SONGS

Press **▶▶** or **◀◀** **button** or rotate **Function/Select knob** to select a song.

## AUX OPERATION



This unit can be connected to any portable music devices such as MP3 Player, TV and DVD through the AUX IN located at the back of the unit. Press **MODE button** to change the mode to “AUX Input 1” (back) or “AUX Input 2” (DMD drawer) mode.

*Please note: In this mode, all controls and functions must be controlled from your music device.*

## USB OPERATION

### SWITCHING TO USB MODE

If there is no USB inserted in the driver:

Insert a USB through the USB port located at the back of the unit then press **MODE button** to change to USB mode.

If a USB is already inserted in the driver:

Press **MODE button** to change to USB mode.

### SELECTING SONGS

Press **▶▶** or **◀◀** button or rotate **Function/Select knob** to select a song.

Press and Hold **▶▶** or **◀◀** button to fast forward or rewind a song.

### SELECTING SONGS BY FOLDER

*Note: Make sure RPT MODE is off before using this function*

Press **5 button** or **6 button** to select folder downward or upward. If a folder does not exist or does not have music files, it will be skipped.

### SEARCHING TRACK NUMBER DIRECTLY

Press the AS/PS button “Select:0000” will show on the display. The 0's indicates the track numbers. Use the **PRESET buttons** to select the desired track number. When finished, press **Function/Select knob** to confirm and play.

*Explain as follows:*

- If you want to search track number 1176, you have to press **1 button** one time to get 1, then press **2 button** one time to get 1, then press **3 button** seven times to get 7, then press **4 button** six times to get 6
- Press **Function/Select knob** to confirm and play.

### DISPLAY INFORMATION (music files only)

Press **MENU button** to display information (i.e. folder name, song title, album name, artist, etc.) of the song that is currently playing (if available).

## PREVIEWING ALL TRACKS

Press **1 button** to play all songs in intro mode. The unit will play the first 10 seconds of each song continuously until you press **1 button** again to stop intro function.

## PLAYING ALL TRACKS IN RANDOM ORDER

Press **2 button** and select “Random: Track” to play all tracks in random. Press **2 button** and select “Random: Off” to cancel random function.

## REPEAT FUNCTION

Press **3 button** and select “Repeat: ONE” to repeat same song. Press **3 button** and select “Repeat: ALL” to repeat all tracks or to stop repeat function.

## PAUSE FUNCTION

Press **4 button** to pause player. Press **4 button** again to resume play.

### IMPORTANT NOTE:

*Some USB devices may not be compatible with the unit.*

*Some USB devices may take more than 45 seconds to initiate after plugging in. If this happen, try to remove the USB memory stick and insert it again.*

### CAUTION

If there are important files in the USB device, do not connect it to the main unit to play. Any wrong operation may cause file loss. Our company assumes no responsibility for lost files or directories.

<b>Media type</b>	USB (can support USB2.0 but the speed is USB1.1.)
<b>Capacity</b>	up to 2000 songs

## SD CARD OPERATION

### SWITCHING TO SD MODE

If SD card is already inserted in the driver:

Press **MODE** button to change to SD Card mode.

If there is no SD card inserted in the driver:

Insert SD card through the SD card port located in front of the unit. Press MODE button to change to SD Card mode.

**Warning!** Do not over-insert the card as this can damage the contact pins.

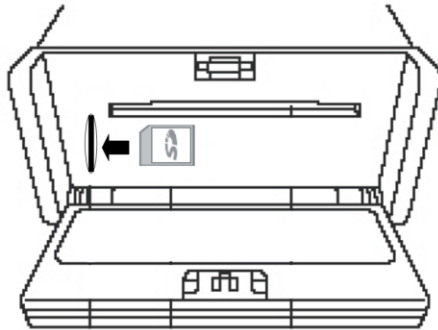

Refer USB operation on pages 17 for further instructions.

## REMOVING THE SD CARD

Firmly press the card into the slot and release it. The card should pop partially out of the slot.

### IMPORTANT NOTE:

*Some Memory Card devices may not be compatible with the unit.*

*Some Memory Card devices may take more than 45 seconds to initiate after plugging in. If this happen, try to remove the memory card and insert it again.*

## CAUTION

Be sure to use only recommended SD cards (<32GB). Using non-recommended SD cards could cause data loss and damage your device. If there are important files in the memory card, do not connect it to the main unit to play. Any wrong operation may cause file loss. Our company assumes no responsibility for lost files or directories.

<b>Media type</b>	Memory Card
<b>Capacity</b>	Standard SD: up to 2000 songs SDHC: up to 2000 songs
<b>Dimensions</b>	32 x 24 x 2.1 mm

## **COMPATIBLE ACCESSORIES *(sold separately)***

**MR45R Wired Remote Control** – connect to the back of the unit labeled “TO MR45R”. You can add up to 2 MR45R in conjunction with CMR-Y7.

**MRR21 IR Wireless Remote Control** - the IR eye is located next to the volume button and must be in line of site for the remote to operate.

**ACX-10 USB/AUX accessory extension cable** - provides easy access to your USB input and Aux input

**IC-3.5PM MP3 /iPod/ Satellite Radio Panel Mount Adapter** - allows you to connect your MP3 player, iPod® or satellite radio to any audio device with RCA inputs

**IR-4050 IR Sensor with 9' cable** - connect this IR sensor to the IR port located at the back of the unit. This is an IR sensor, another way to point your MRR21 without going to the front of the stereo.

## TROUBLESHOOTING

<b>PROBLEM</b>	<b>CAUSE</b>	<b>CORRECTIVE ACTION</b>
No power	Blown fuse, power wires disconnected	Check the fuse and power wire or ground wire connection
No sound	Mute is on, Volume set at minimum, wiring is not properly connected	Turn Mute to off, adjust volume to a desired level, check the speaker wire
Cannot read some USB devices	This unit is not 100% compatible with all USB devices or the USB devices has special format.	Try to format the USB device in FAT 16/32 standard
Unit powers off by itself	The battery may be too low (the unit operating voltage is 10.8v to 15.6v).	
Unit takes about 45 seconds to recognize some USB device or SD card	This is normal. The unit sometimes takes longer time to read all the files inside the USB device or SD Card.	Try to remove the USB device or memory card and insert it again.
Operations keys do not work		Press the RESET button
The unit picks up engine noise.		Check the ground wire.
The radio does not work. The radio station automatic selection does not work	The antenna cable is not connected or the signals are too weak	Insert the antenna cable firmly or select a station manually

## TECHNICAL SPECIFICATIONS

<b>TUNER(AM)</b>	
Frequency Range	530-1710 KHz
Usable Sensitivity	32 dBuV
<b>TUNER(FM)</b>	
Frequency Range	87.5-107.9 MHz
Channel Step	200KHz
Sensitivity	2.8 uV
Stereo Separation	30dB
Signal to Noise Ratio	50dB
<b>LINE-OUT</b>	
Output	5 Volt ( max )
Impedance	33 Ohm
<b>GENERAL</b>	
Power Supply	12V DC (10.8-15.6V allowable)
Speaker Impedance	4 or 8 ohm
Output Power	45W x 4CH
Fuse	15A

***NOTE: Specification & design subject to change without notice for improvements.***

## WARRANTY INFORMATION

This unit is warranted to be free of defects in material and workmanship for a period of two years. Warranty is subject to proper installation and operation within the published specifications. Except as provided below, Poly-Planar will repair or replace, at its discretion, any unit returned prepaid to our facility with proper documentation and determined to be defective in normal use. Poly-Planar is not liable for any consequential damages.

### LIMITS OF LIABILITY

Proof of date of purchase is required for warranty service of this unit.

Poly-Planar will consider this warranty void if unit has been tampered with or has had serial number altered, defaced or removed. Poly-Planar warranty does not cover damage incurred in transit, accident, abuse, misuse, negligence, fire, flood, lightning, or unauthorized service. This warranty assumes no responsibility for damages incurred during installation of this equipment. This warranty does not cover labor costs for removal of defective unit or reinstallation of replacement unit. This warranty covers normal consumer use only. In no event shall Poly-Planar be liable for special, incidental, or consequential damages.

To obtain service under this warranty, please call Poly-Planar for a **RETURN AUTHORIZATION NUMBER**. After a return authorization number is issued, return unit with proof of purchase and a letter stating your return address, daytime phone number and detail description of the problem or malfunction

***poly-planar***

Maryland, USA

(410) 761-4000

[www.polyplanar.com](http://www.polyplanar.com)





-----  
detach here  
-----



### WARRANTY REGISTRATION

In order to validate your Warranty please complete this Registration Card within 1 week of purchase. Detach and mail to Poly-Planar Group, LLC P.O. Box 409, Hanover, MD 21076  
***A copy of proof of purchase must accompany this registration***

SERIAL NUMBER	MODEL NUMBER	DATE OF PURCHASE
LAST NAME	FIRST NAME	EMAIL (optional)
STREET ADDRESS		
CITY	STATE	ZIP
DEALER	CITY	STATE